

TECHNICAL DATA SHEET - HEAVY DUTY TOOTH

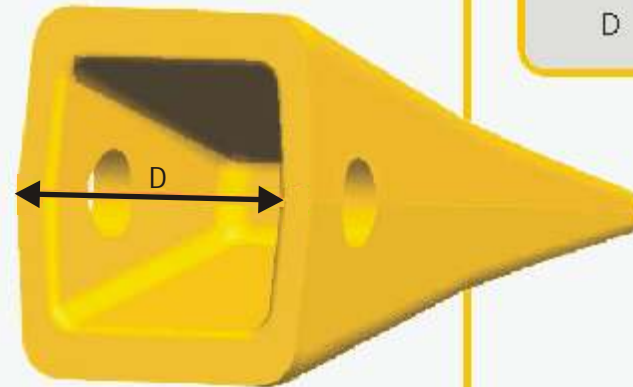
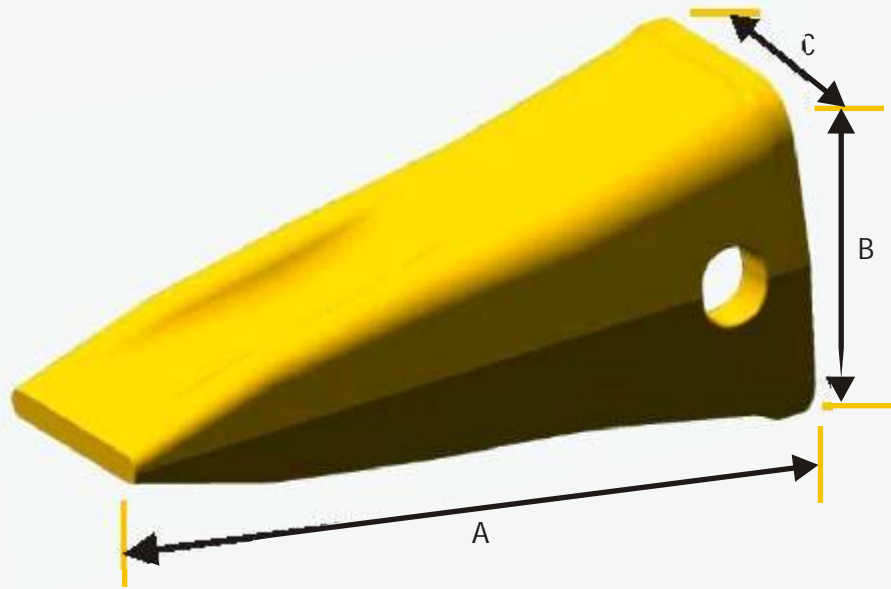

Label	Dimensions
A	253 mm
B	116 mm
C	104 mm
D	89 mm

NOTES:

CAST STEEL BUCKET TOOTH
HEAVY DUTY SHAPE FOR INCREASED WEAR LIFE

IMPORTANT- PLEASE ENSURE YOU CHECK YOUR DIMENSIONS CAREFULLY
BEFORE ORDERING TO ENSURE THE CORRECT PARTS ARE SUPPLIED.

