

TECHNICAL DATA SHEET - STANDARD TOOTH

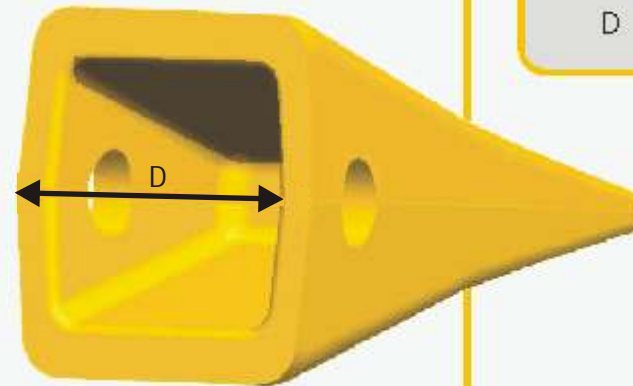
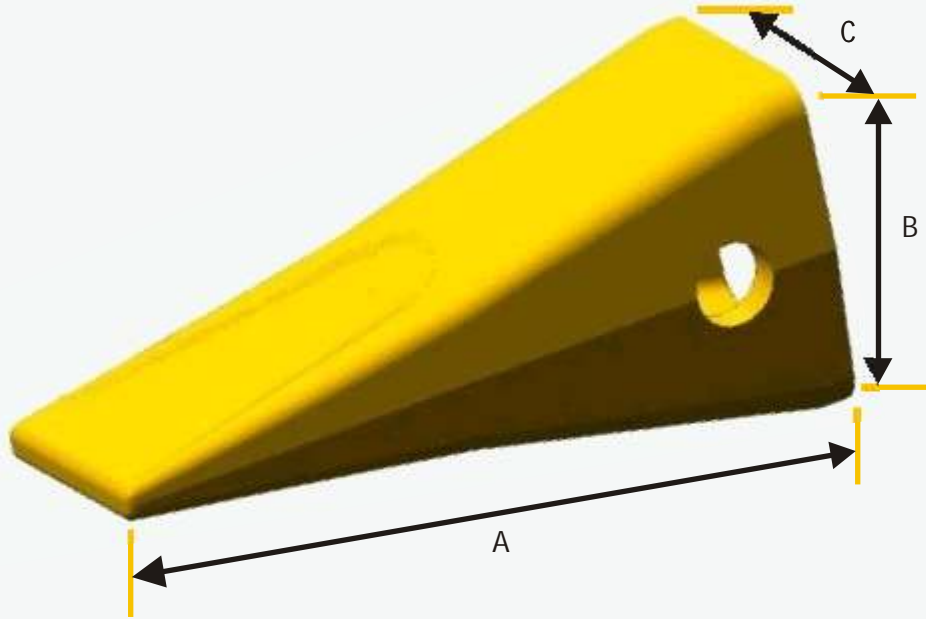

Label	Dimensions
A	245 mm
B	111 mm
C	101 mm
D	89 mm

NOTES:

CAST STEEL BUCKET TOOTH

IMPORTANT- PLEASE ENSURE YOU CHECK YOUR DIMENSIONS CAREFULLY BEFORE ORDERING TO ENSURE THE CORRECT PARTS ARE SUPPLIED.

