

TECHNICAL DATA SHEET - STANDARD TOOTH

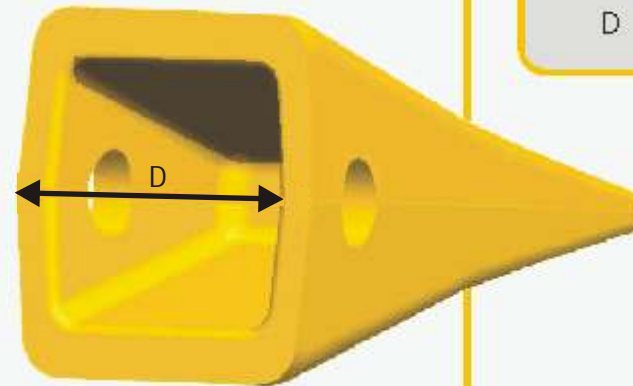
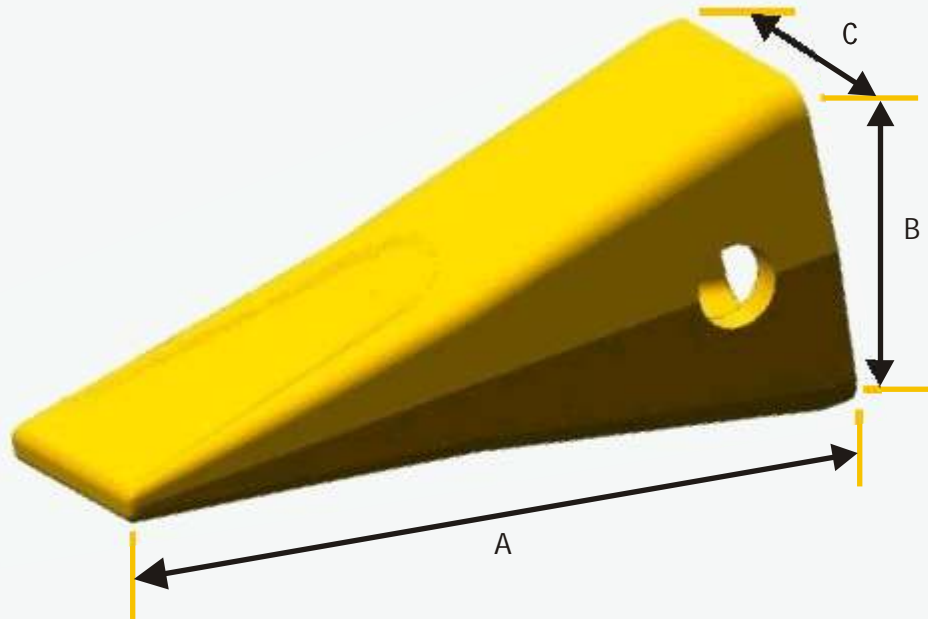

Label	Dimensions
A	213 mm
B	99 mm
C	87 mm
D	76 mm

NOTES:

CAST STEEL BUCKET TOOTH

IMPORTANT- PLEASE ENSURE YOU CHECK YOUR DIMENSIONS CAREFULLY BEFORE ORDERING TO ENSURE THE CORRECT PARTS ARE SUPPLIED.

