

TECHNICAL DATA SHEET - RUBBER CLIP-ON TRACK PAD

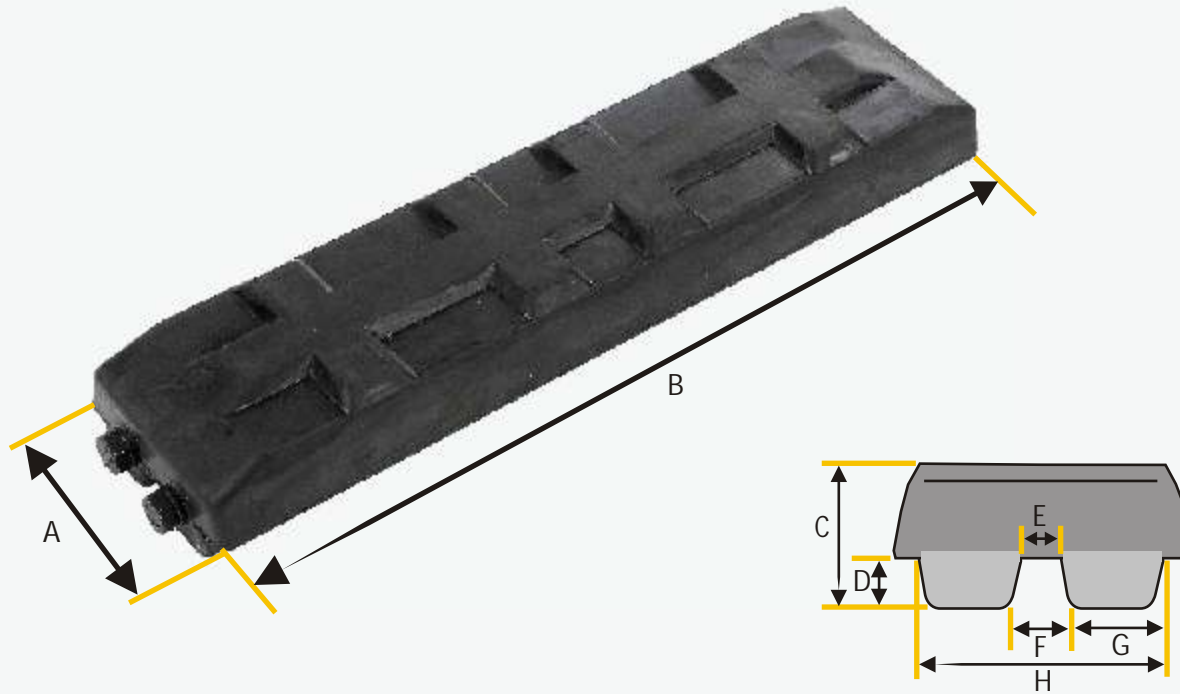

Label	Dimensions
A	117 mm
B	596 mm
C	68 mm
D	20 mm
E	12 mm
F	18 mm
G	29 mm
H	80 mm

NOTES:

RUBBER CLIP ON TRACK PAD

IMPORTANT- PLEASE ENSURE YOU CHECK YOUR DIMENSIONS CAREFULLY BEFORE ORDERING TO ENSURE THE CORRECT PARTS ARE SUPPLIED.

