

TECHNICAL DATA SHEET - RUBBER CLIP-ON TRACK PAD

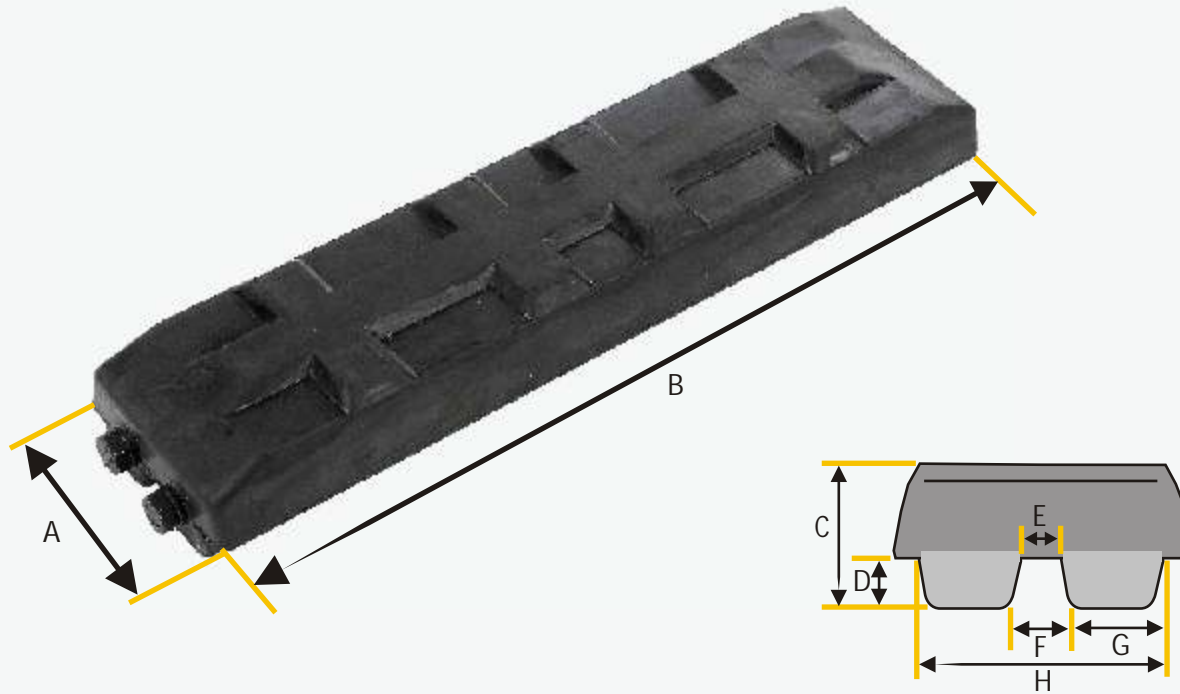

Label	Dimensions
A	153 mm
B	590 mm
C	85 mm
D	26 mm
E	16 mm
F	22 mm
G	47 mm
H	122 mm

NOTES:

RUBBER CLIP ON TRACK PAD

IMPORTANT- PLEASE ENSURE YOU CHECK YOUR DIMENSIONS CAREFULLY BEFORE ORDERING TO ENSURE THE CORRECT PARTS ARE SUPPLIED.

